

Standard cylinders DNU/DNUL to ISO 6431

Key features at a glance

ISO and standard cylinders

1.1



DNU/DNUL

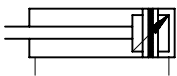

- - Note
For new applications use
type DNC
(→ 1.1-54).

- - Diameters
32 ... 125 mm

- - Stroke lengths
10 ... 2000 mm

- - Note
Wearing parts kits
→ Vol.1 / i-38

- Double-acting
- With adjustable end-position cushioning at both ends
- For contactless end-position sensing
- DNUL: Secured against rotation by means of square piston rod

DNU

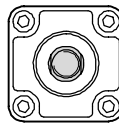

DNUL with non-rotating piston rod

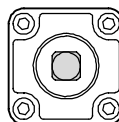

Variants:

S2: Through piston rod



S3: Stainless steel piston rod



S6: Heat resistant seals up to 150 °C



S8: High corrosion resistance



S26: Through piston rod with heat-resistant seals up to 150 °C



The variants can be combined with one another.

Standard cylinders DNU/DNUL to ISO 6431

Key features at a glance

ISO and standard cylinders

Mounting options

Basic cylinder installation
Mounting at front

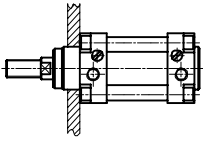

Mounting at rear

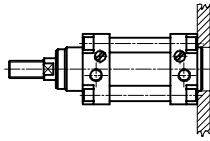

Installation types with mounting attachments

Foot mounting
HN

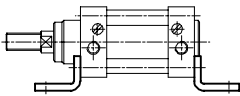

Flange mounting
FN

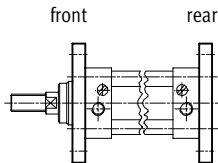

Swivel flange
SN/SSN

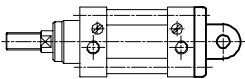

Trunnion mounting kit
ZNU

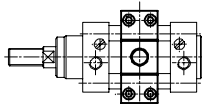

Swivel flange
SN
with clevis foot LN

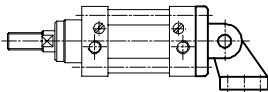

Swivel flange
SN
with clevis foot LSN
(lateral displacement max. 5°)

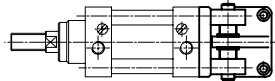

Proximity sensor
SMEO-1/SMT0-1/SMPO-1

→ 1.10-40



Mounting kit
SMBU
for proximity sensor

→ 1.10-42

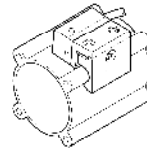

Clevis foot
LN/LSN

→ 1.8-14



Trunnion support
LNZ

→ 1.8-14



Cylinder accessories for piston rod

→ 1.8-0



Guide unit
FEN

→ 1.8-26

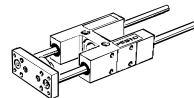

Adapter kit
DPNN for four-position cylinder

→ 1.1-127



∅ [mm]	Standard stroke lengths DNU-...											Stroke length			
	[mm]	25	40	50	80	100	125	160	200	250	320	400	500	DNU-... [mm]	DNUL-... [mm]
32														10 ... 2000	10 ... 300
40														10 ... 2000	10 ... 400
50														10 ... 2000	10 ... 500
63														10 ... 2000	10 ... 500
80														10 ... 2000	10 ... 600
100														10 ... 2000	10 ... 600

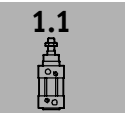

Standard cylinders DNU/DNUL to ISO 6431

Overview and ordering data

ISO and standard cylinders

DNU/DNUL*

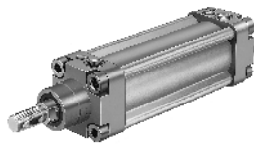

1.1



X stroke lengths

Variant S2

Variant S3

Variant S6

Variant S8

Variant S26

with non-rotating piston rod

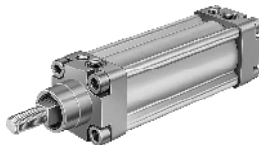

X stroke lengths

Variant S6

Accessories

Foot mounting

Flange mounting

Trunnion mounting kit

Swivel flange

Spherical swivel flange

Adapter kit

Stroke [mm]	∅ 32 [mm]		∅ 40 [mm]		∅ 50 [mm]		
	Part No.	Type	Part No.	Type	Part No.	Type	
25	14 121	DNU-32-25-PPV-A	14 132	DNU-40-25-PPV-A	14 143	DNU-50-25-PPV-A	
40	14 122	DNU-32-40-PPV-A	14 133	DNU-40-40-PPV-A	14 144	DNU-50-40-PPV-A	
50	14 123	DNU-32-50-PPV-A	14 134	DNU-40-50-PPV-A	14 145	DNU-50-50-PPV-A	
80	14 124	DNU-32-80-PPV-A	14 135	DNU-40-80-PPV-A	14 146	DNU-50-80-PPV-A	
100	14 125	DNU-32-100-PPV-A	14 136	DNU-40-100-PPV-A	14 147	DNU-50-100-PPV-A	
125	14 126	DNU-32-125-PPV-A	14 137	DNU-40-125-PPV-A	14 148	DNU-50-125-PPV-A	
160	14 127	DNU-32-160-PPV-A	14 138	DNU-40-160-PPV-A	14 149	DNU-50-160-PPV-A	
200	14 128	DNU-32-200-PPV-A	14 139	DNU-40-200-PPV-A	14 150	DNU-50-200-PPV-A	
250	14 129	DNU-32-250-PPV-A	14 140	DNU-40-250-PPV-A	14 151	DNU-50-250-PPV-A	
320	34 704	DNU-32-320-PPV-A	34 705	DNU-40-320-PPV-A	34 706	DNU-50-320-PPV-A	
400	32 473	DNU-32-400-PPV-A	32 475	DNU-40-400-PPV-A	32 477	DNU-50-400-PPV-A	
500	32 474	DNU-32-500-PPV-A	32 476	DNU-40-500-PPV-A	32 478	DNU-50-500-PPV-A	
...	14 120	DNU-32-...-PPV-A	14 131	DNU-40-...-PPV-A	14 142	DNU-50-...-PPV-A	
Variant S2	...	14 186	DNU-32-...-PPV-A-S2	14 187	DNU-40-...-PPV-A-S2	14 188	DNU-50-...-PPV-A-S2
Variant S3	...	158 844	DNU-32-...-PPV-A-S3	158 845	DNU-40-...-PPV-A-S3	158 846	DNU-50-...-PPV-A-S3
Variant S6	...	14 919	DNU-32-...-PPV-A-S6	14 920	DNU-40-...-PPV-A-S6	14 921	DNU-50-...-PPV-A-S6
Variant S8	...	158 850	DNU-32-...-PPV-A-S8	158 851	DNU-40-...-PPV-A-S8	158 852	DNU-50-...-PPV-A-S8
Variant S26	...	14 925	DNU-32-...-PPV-A-S26	14 926	DNU-40-...-PPV-A-S26	14 927	DNU-50-...-PPV-A-S26
25	-	-	-	-	-	-	
40	-	-	-	-	-	-	
50	-	-	-	-	-	-	
80	-	-	-	-	-	-	
100	-	-	-	-	-	-	
125	-	-	-	-	-	-	
160	-	-	-	-	-	-	
200	-	-	-	-	-	-	
250	-	-	-	-	-	-	
320	-	-	-	-	-	-	
400	-	-	-	-	-	-	
500	-	-	-	-	-	-	
...	15 602	DNUL-32-...-PPV-A	15 603	DNUL-40-...-PPV-A	15 604	DNUL-50-...-PPV-A	
Variant S6	...	15 660	DNUL-32-...-PPV-A-S6	15 661	DNUL-40-...-PPV-A-S6	15 662	DNUL-50-...-PPV-A-S6
	5 135	HN-35	5 136	HN-40	5 137	HN-50	
	5 141	FN-32	5 142	FN-40	5 143	FN-50	
	14 210	ZNU-32	14 211	ZNU-40	14 212	ZNU-50	
	5 153	SN-32	5 154	SN-40	5 155	SN-50	
	34 285	SSN-32	34 286	SSN-40	34 287	SSN-50	
	13 468	DPNN-32**	13 469	DPNN-40**	13 470	DPNN-50**	

* The scope of delivery includes a hexagonal nut for the piston rod thread.

** Scope of delivery: 1 flange, 8 threaded studs, 8 DIN 125 washers and 8 hex nuts.

Standard cylinders DNU/DNUL to ISO 6431

Overview and ordering data

ISO and standard cylinders

Ø 63 [mm]		Ø 80 [mm]		Ø 100 [mm]	
Part No.	Type	Part No.	Type	Part No.	Type
14 154	DNU-63-25-PPV-A	14 165	DNU-80-25-PPV-A	14 176	DNU-100-25-PPV-A
14 155	DNU-63-40-PPV-A	14 166	DNU-80-40-PPV-A	14 177	DNU-100-40-PPV-A
14 156	DNU-63-50-PPV-A	14 167	DNU-80-50-PPV-A	14 178	DNU-100-50-PPV-A
14 157	DNU-63-80-PPV-A	14 168	DNU-80-80-PPV-A	14 179	DNU-100-80-PPV-A
14 158	DNU-63-100-PPV-A	14 169	DNU-80-100-PPV-A	14 180	DNU-100-100-PPV-A
14 159	DNU-63-125-PPV-A	14 170	DNU-80-125-PPV-A	14 181	DNU-100-125-PPV-A
14 160	DNU-63-160-PPV-A	14 171	DNU-80-160-PPV-A	14 182	DNU-100-160-PPV-A
14 161	DNU-63-200-PPV-A	14 172	DNU-80-200-PPV-A	14 183	DNU-100-200-PPV-A
14 162	DNU-63-250-PPV-A	14 173	DNU-80-250-PPV-A	14 184	DNU-100-250-PPV-A
34 707	DNU-63-320-PPV-A	34 708	DNU-80-320-PPV-A	34 709	DNU-100-320-PPV-A
32 479	DNU-63-400-PPV-A	32 481	DNU-80-400-PPV-A	32 483	DNU-100-400-PPV-A
32 480	DNU-63-500-PPV-A	32 482	DNU-80-500-PPV-A	32 484	DNU-100-500-PPV-A
14 153	DNU-63-...-PPV-A	14 164	DNU-80-...-PPV-A	14 175	DNU-100-...-PPV-A
14 189	DNU-63-...-PPV-A-S2	14 190	DNU-80-...-PPV-A-S2	14 191	DNU-100-...-PPV-A-S2
158 847	DNU-63-...-PPV-A-S3	158 848	DNU-80-...-PPV-A-S3	158 849	DNU-100-...-PPV-A-S3
14 922	DNU-63-...-PPV-A-S6	14 923	DNU-80-...-PPV-A-S6	14 924	DNU-100-...-PPV-A-S6
158 853	DNU-63-...-PPV-A-S8	158 854	DNU-80-...-PPV-A-S8	158 855	DNU-100-...-PPV-A-S8
14 928	DNU-63-...-PPV-A-S26	14 929	DNU-80-...-PPV-A-S26	14 930	DNU-100-...-PPV-A-S26
-		-		-	
-		-		-	
-		-		-	
-		-		-	
-		-		-	
-		-		-	
-		-		-	
-		-		-	
-		-		-	
-		-		-	
-		-		-	
-		-		-	
-		-		-	
-		-		-	
-		-		-	
-		-		-	
-		-		-	
-		-		-	
-		-		-	
-		-		-	
-		-		-	
-		-		-	
-		-		-	
15 605	DNUL-63-...-PPV-A	15 606	DNUL-80-...-PPV-A	15 607	DNUL-100-...-PPV-A
15 663	DNUL-63-...-PPV-A-S6	15 664	DNUL-80-...-PPV-A-S6	15 665	DNUL-100-...-PPV-A-S6
5 138	HN-63	5 139	HN-80	5 140	HN-100
5 144	FN-63	5 145	FN-80	5 146	FN-100
14 213	ZNU-63	14 214	ZNU-80	14 215	ZNU-100
5 156	SN-63	5 157	SN-80	5 158	SN-100
34 288	SSN-63	34 289	SSN-80	34 290	SSN-100
13 471	DPNN-63**	13 472	DPNN-80**	13 473	DPNN-100**

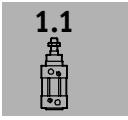

Standard cylinders DNU/DNUL to ISO 6431

Technical data

ISO and standard cylinders

DNU/DNUL

Max. operating pressure		12 bar				
Temperature range		-20 ... +80 °C (observe operating range of proximity sensor)				
Material		Bearing and end caps: aluminium; cylinder barrel: anodised aluminium; piston rod: high-alloy steel; seals: polyurethane				
∅ [mm]	Thrust at 6 bar* [N]	Return force at 6 bar* [N]	Thrust = return force at 6 bar for S2 [Nm]	Max. torque at the piston rod for DNUL** [Nm]	Cushioning length [mm]	Connection
32	482	415	393	0.8	19	G1/8
40	753	633	586	1.1	21	G1/4
50	1178	990	924	1.5	23	G1/4
63	1870	1682	1601	1.5	23	G3/8
80	3015	2720	2615	3.0	30	G3/8
100	4712	4418	4221	3.0	30	G1/2

* Theoretical values

** The max. permissible torque must also be observed when fitting attachments to the piston rod.

Weights

∅ [mm]	Basic weight [kg]	Weight per 10 mm stroke [kg]	Mounting attachments/material				
			HN Galvanised steel [kg]	FN Die-cast aluminium [kg]	ZNU Die-cast aluminium [kg]	SN Die-cast aluminium [kg]	SSN Spheroidal graphite cast iron [kg]
32	0.483	0.026	0.140	0.080	0.300	0.110	0.160
40	0.727	0.036	0.220	0.110	0.515	0.180	0.260
50	1.146	0.048	0.380	0.190	0.710	0.260	0.400
63	1.674	0.057	0.580	0.340	1.190	0.460	0.720
80	2.662	0.076	1.100	0.520	1.590	0.700	1.070
100	3.864	0.090	1.480	0.900	2.050	1.280	1.780

Max. permissible torque at the piston rod for DNUL

(Diagrams → 1.1-123)

Examples for ∅ 32 mm:

Example 1:
Stroke length = 150 mm
Result: Permissible
Lateral force = 9.5 N
Lever arm = 84 mm

Example 2:
Lateral force = 40 N
Result: Permissible
Stroke length = 28 mm
Lever arm = 20 mm

Example 3:
Stroke length = 150 mm
Lever arm = 100 mm

$$F_Q = \frac{\text{Max. Torque } 800 \text{ Nmm}}{\text{Leverarm } 100 \text{ mm}} = 8 \text{ N}$$

Result: Permissible
 $F_Q \ 8 \text{ N} < F_Q \text{ max. } 9.5 \text{ N}$

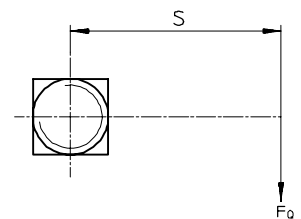

Standard cylinders DNU/DNUL to ISO 6431

Technical data

ISO and standard cylinders

Lateral force F_Q in relation to stroke length and lever arm s

DNUL

DNUL-32

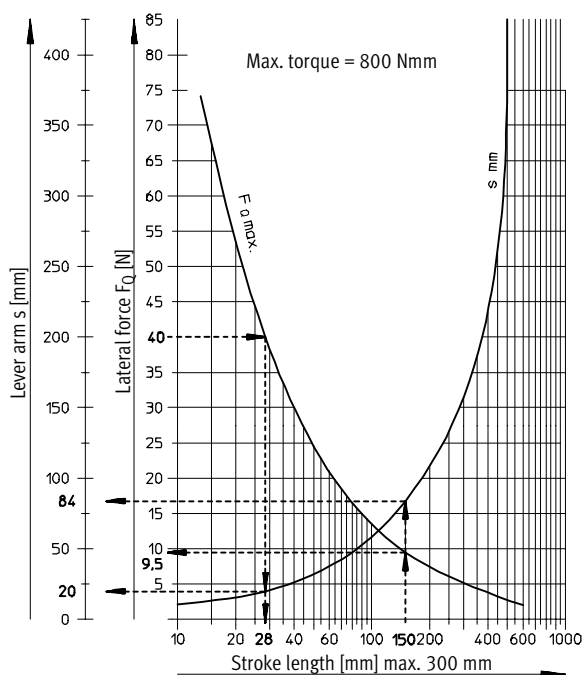

DNUL-40

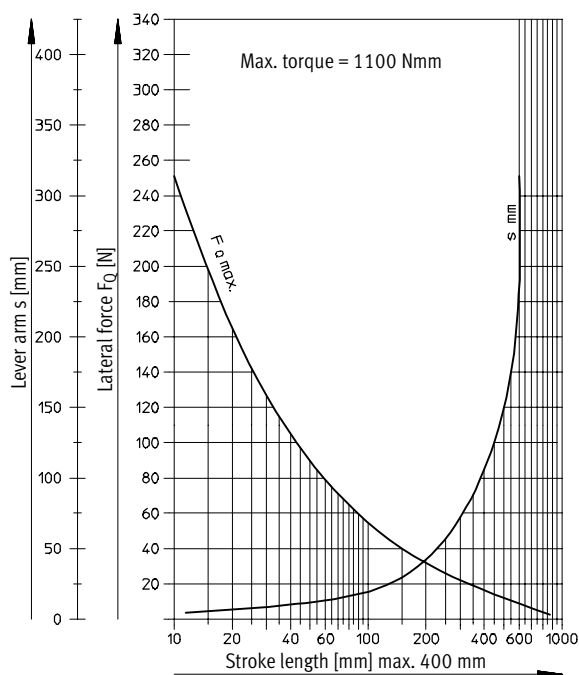

DNUL-50
DNUL-63

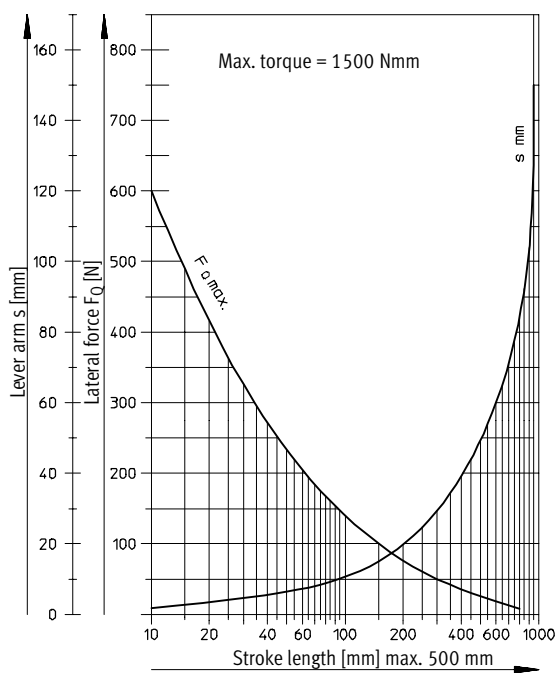

DNUL-80
DNUL-100

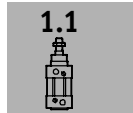
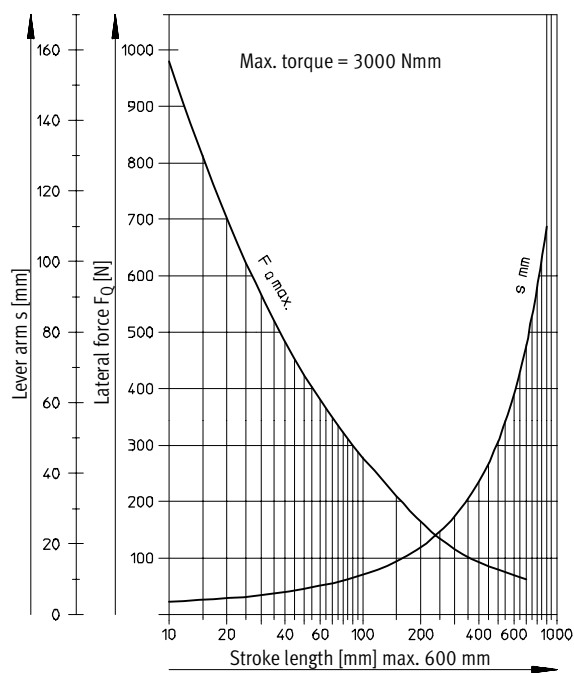

Standard cylinders DNU/DNUL to ISO 6431

Dimensions

ISO and standard cylinders

DNU/DNUL

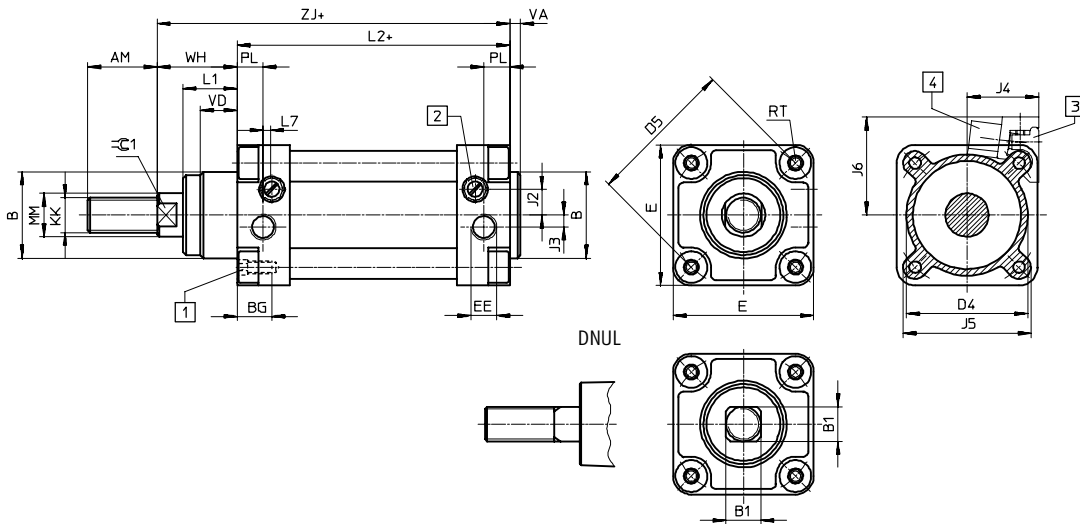

1.1



Variant S2/S26

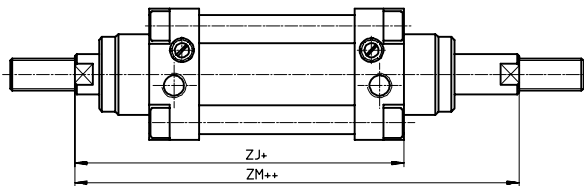

- 1 Socket head screw with female thread
 - 2 Regulating screw for adjustable end-position cushioning
 - 3 Mounting kit SMBU-...-B for cylinder sensor
 - 4 Cylinder sensors SMEO-1/SMT0-1/SMPO-1
- + = plus stroke length
++ = plus 2 x stroke lengths

∅	AM	B	B1	BG	D4	D5	E	EE	J2	J3	J4	J5	J6
[mm]		∅ f8	f8		∅	∅							
32	22	30	10	13	37	46	45	G1/8	7	-	25	43.7	37
40	24	35	12	13	46	56	54	G1/4	9	4.5	29	50.6	41
50	32	40	16	16	56	68	65	G1/4	11.5	5.5	33.5	59.1	45.5
63	32	45	16	19	70	84	80	G3/8	13	11.5	42	72.7	53
80	40	48	21	20	87	100	96	G3/8	17	16	49	84.1	60
100	40	52	21	20	107	132	126	G1/2	17.5	18	57.5	106.7	68.5

∅	KK	L1	L2	L7	MM	PL	RT	VA	VD	WH	ZJ	ZM	≈C1
[mm]					∅ f8								
32	M10x1.25	16	94	9.5	12	9	M5	4	16	26	120	146	10
40	M12x1.25	20	105	6	16	12	M5	5.5	20	30	135	165	13
50	M16x1.5	25	106	4	20	12	M6	5	17	37	143	180	17
63	M16x1.5	28	115	-	20	14.5	M6	6	28	40	155	195	17
80	M20x1.5	34	124	-	25	14	M8	6	23	48	172	220	22
100	M20x1.5	40	134	-	25	16	M8	7	23	53	187	240	22

Standard cylinders DNU/DNUL to ISO 6431, accessories

Dimensions

ISO and standard cylinders

Foot mounting
HN
(2 feet and 4 mounting screws)

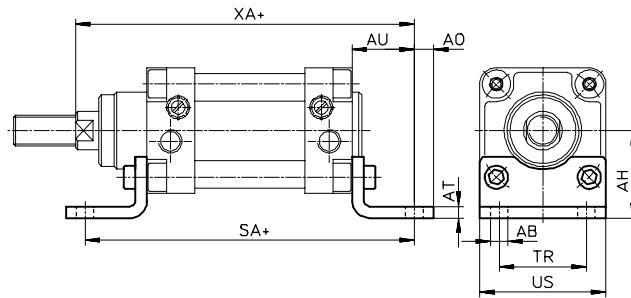

Mounting attachments

Flange mounting
FN
(1 flange and 4 mounting screws)

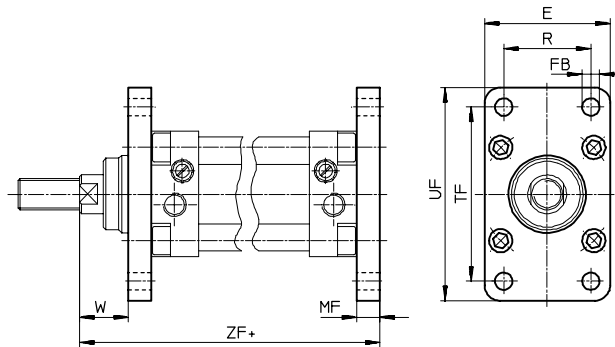

Trunnion mounting kit
ZNU
for trunnion support LNZ
(1 trunnion and 4 mounting screws)
The kit can be attached to the cylinder profile barrel at any position.

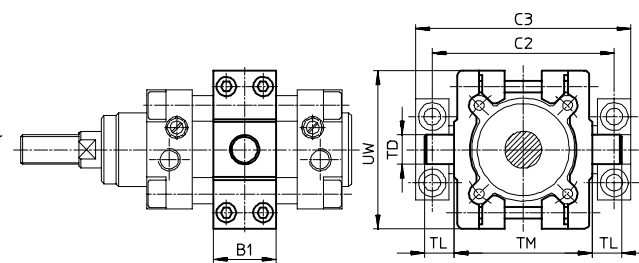

∅	AB	AH	AO	AT	AU	B1	C2	C3	E	FB	MF	R
[mm]	∅									∅		
32	7	32	8	4	24	30	65	80	45	7	10	32
40	9	36	10	5	28	32	81	99	54	9	10	36
50	9	45	10	6	32	34	93	111	65	9	12	45
63	9	50	15	6	35	41	110	130	80	9	15	50
80	12	63	17	8	43	44	130	150	96	12	18	63
100	14	71	14	8	43	44	157	182	126	14	18	75

∅	SA	TD	TF	TL	TM	TR	UF	UW	US	W	XA	ZF
[mm]		∅ e9										
32	142	12	64	12	50	32	77	65	45	16	144	130
40	161	16	72	16	63	36	90	75	54	20	163	145
50	170	16	90	16	75	45	110	86	65	25	175	155
63	185	20	100	20	90	50	125	105	80	25	190	170
80	210	20	126	20	110	63	154	120	96	30	215	190
100	220	25	150	25	132	75	186	140	126	35	230	205

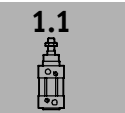

Standard cylinders DNU/DNUL to ISO 6431, accessories

Dimensions

ISO and standard cylinders

Mounting attachments

Swivel flange
SN
for clevis foot LN/LSN
(1 flange with pivot pin and
4 mounting screws)

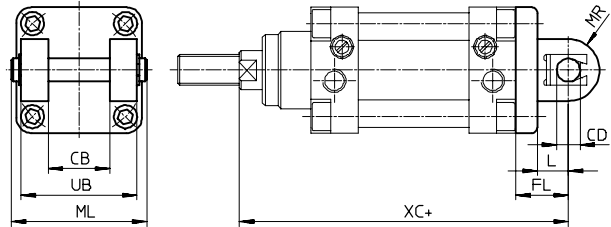

Spherical swivel flange
SSN
(1 flange and 4 mounting screws)

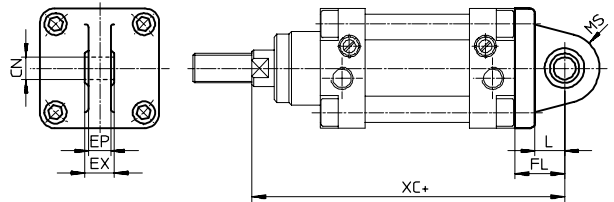

+ = plus stroke length

∅	CB	CD	CN	EP	EX	FL	L	ML	MR	MS	UB	XC
[mm]		∅	∅									
32	26	10	10	10.5	14	22	14	54	10	16	45	142
40	28	12	12	12	16	25	16	62	13	18	52	160
50	32	12	12	12	16	27	16	70	16	19	60	170
63	40	16	16	15	21	35	23	82	18	23	70	190
80	50	16	16	15	21	38	24	102	18	23	90	210
100	60	20	20	18	25	43	28	126	23	30	110	230

1.1



Standard cylinders DNU/DNUL to ISO 6431, accessories

Four-position cylinder

ISO and standard cylinders

For connecting two cylinders DNU with identical \varnothing to a 3 or 4-position cylinder

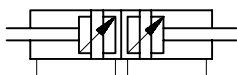

Adapter kit DPNN

Cylinders must be ordered separately. A 3 or 4-position cylinder consists of two separate cylinders whose piston rods advance in opposing directions. This means that depending upon the

actuation and stroke pattern, this type of cylinder can assume up to four positions. In each case the cylinder is driven precisely against a stop. Note

that when one end of the piston rod is fixed, the cylinder barrel executes the movement. The cylinder must be connected with flexible line connections.

1.1



To achieve 3 positions

Two DNU cylinders of identical stroke length must be connected together.

To achieve 4 positions

Two DNU cylinders of different stroke lengths must be connected together.

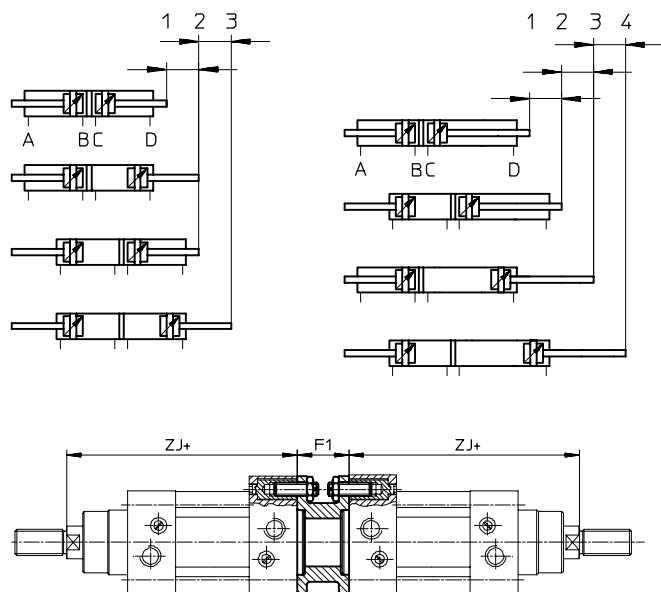

Max. overall stroke length 1000 mm

+ = plus stroke length

\varnothing [mm]	F1	ZJ	Weight [kg]	Material
32	27	120	0.085	Flange: die cast aluminium; threaded studs, hex nuts: steel
40	27	135	0.115	
50	32	143	0.210	
63	34	155	0.360	
80	42	172	0.620	
100	42	187	1.190	